



## LIFTING CAPACITIES

When an excavator is used to lift loads in Europe, it must comply with EN 474-1. Install the following devices, and then turn on the overload warning switch before starting the lifting operation:

- Lifting device
- Lifting safety device

The lifting safety device must include two emergency shut-off valves, one for the boom and the other for the arm.

If the blade is used as an outrigger when lifting loads, the blade cylinder must be equipped with an emergency shut-off valve. Refer to “Lifting safety device (If equipped)” on page 2-95.

### Rated lift capacity chart

- The loads in the charts do not exceed 87% of hydraulic lift capacity or 75% of tipping load.
- Figures marked with an asterisk ( \* , ※ ) are hydraulically-limited capacities.
- The bucket mass is excluded.
- The mass of slings and any other lifting devices shall be deducted from the rated load to determine the net load that may be lifted.
- The load point is the bucket hinge pin.
- The bucket cylinder is fully extended.
- Unit: kg (lbs)

### Lifting device (If equipped)

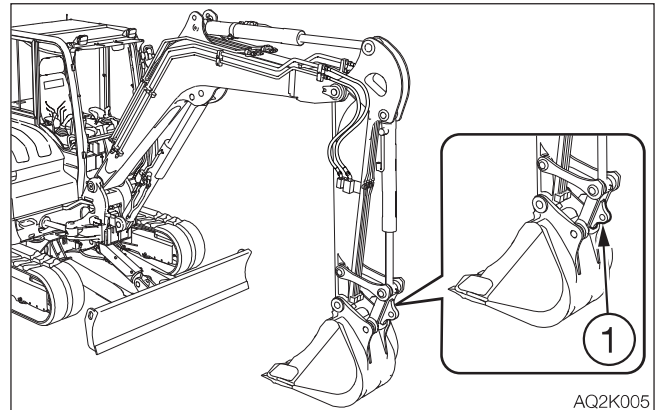

When lifting loads, install the sling on the lifting device (1).

### Load hooking system

A load hooking system must be provided with the following capabilities.

1. A system which can withstand two-and-a-half times the rated lift capacity no matter at what position the load is applied.
2. A system that poses no risk of the lifted load falling from the hooking device. For example, equipped with a hook slippage prevention device.
3. A system that poses no risk of the hooking system slipping from the hoe attachment.



### Inspection before lifting loads

Before lifting loads, inspect the following items to ensure there is no abnormality:

- Inspect for any damage to the attachment, hose or lifting device.
- Confirm that the overload warning device operates.

Turn on the overload warning switch, and then fully raise the boom. If the horn is sounded, the overload warning device is normal.



### **WARNING**

- **Do not attempt to lift or hold any load that is greater than these rated values at their specified load radii and height.**
  - **The rated lift capacities are based on the machine being level and situated on a firm supporting surface. For safe lifting, the operator is expected to make due allowance for the particular job conditions such as soft or uneven ground, non-level condition, load to the machine sides, hazardous conditions, experience of personnel, etc. The operator and other personnel should fully acquaint themselves with the operator's manual furnished by the manufacturer before operating this machine. When operating the machine, the safety rules of the equipment must also be followed.**
  - **Do not travel while lifting a load; It is very dangerous.**
  - **Do not lift loads when the boom is being swung to the right or left. Doing so could cause the machine to tip over.**
-



<Cab> Long arm

**Over Front ; Dozer Blade Up**

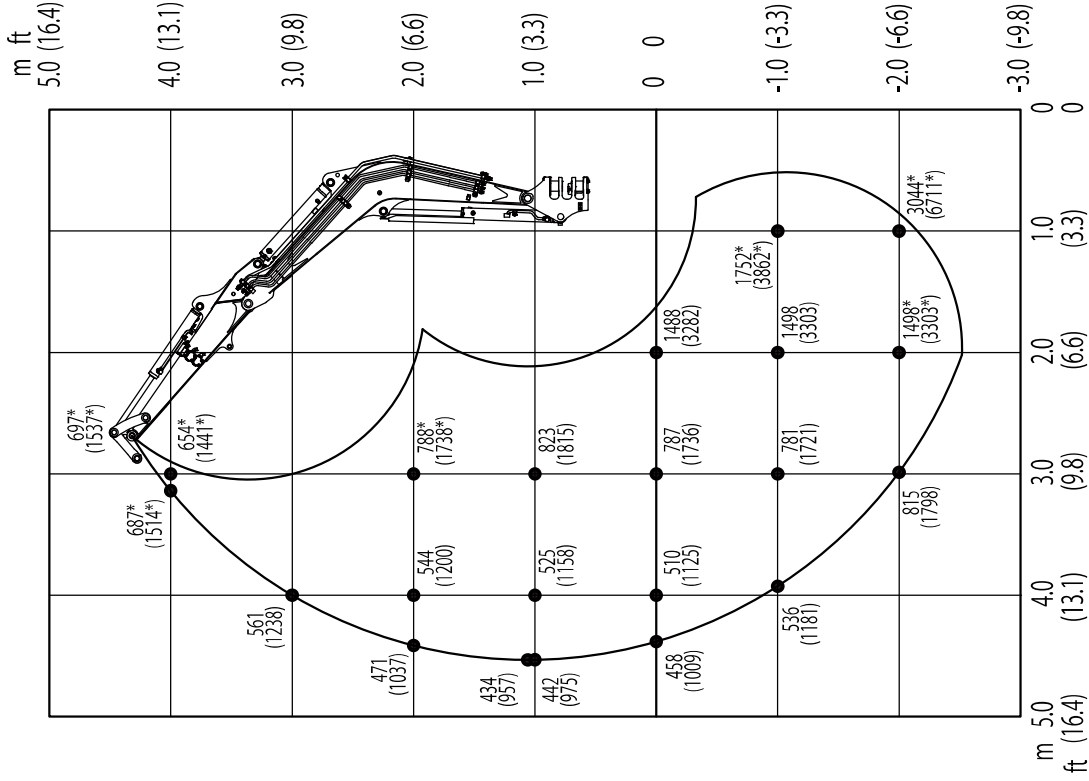

Units: kg(lbs.)

**Over Front ; Dozer Blade Down**

(If equipped with an emergency shut-off valve)

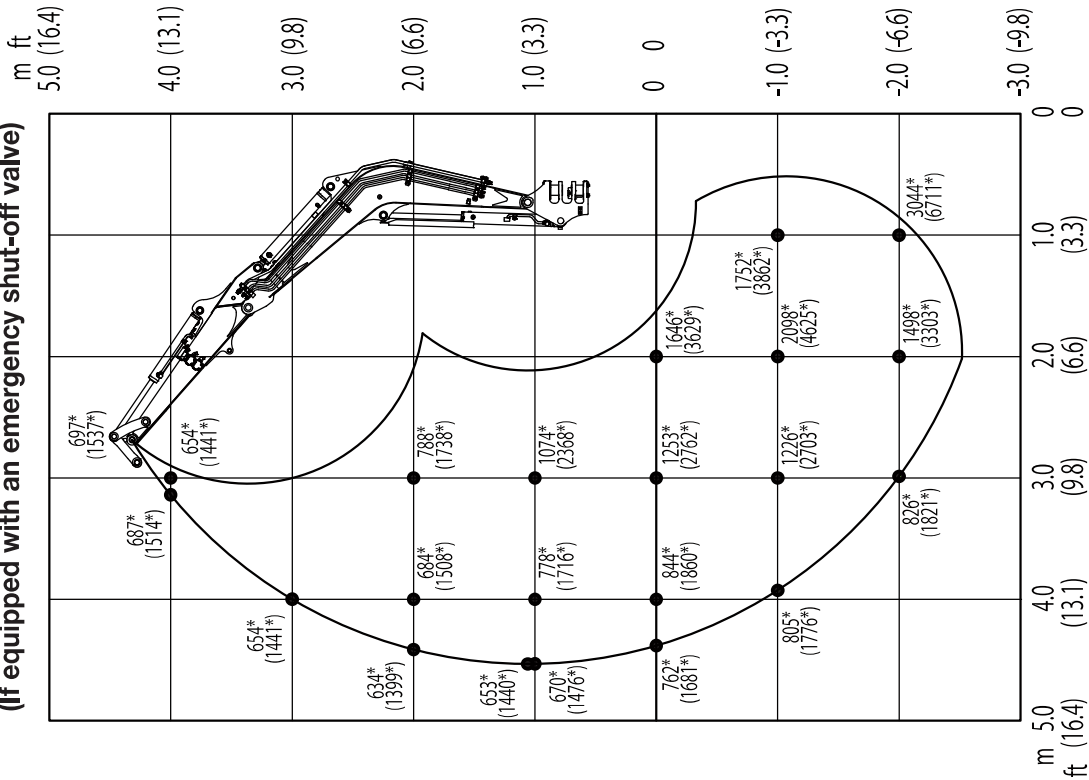



<Cab> Long arm

Over Side

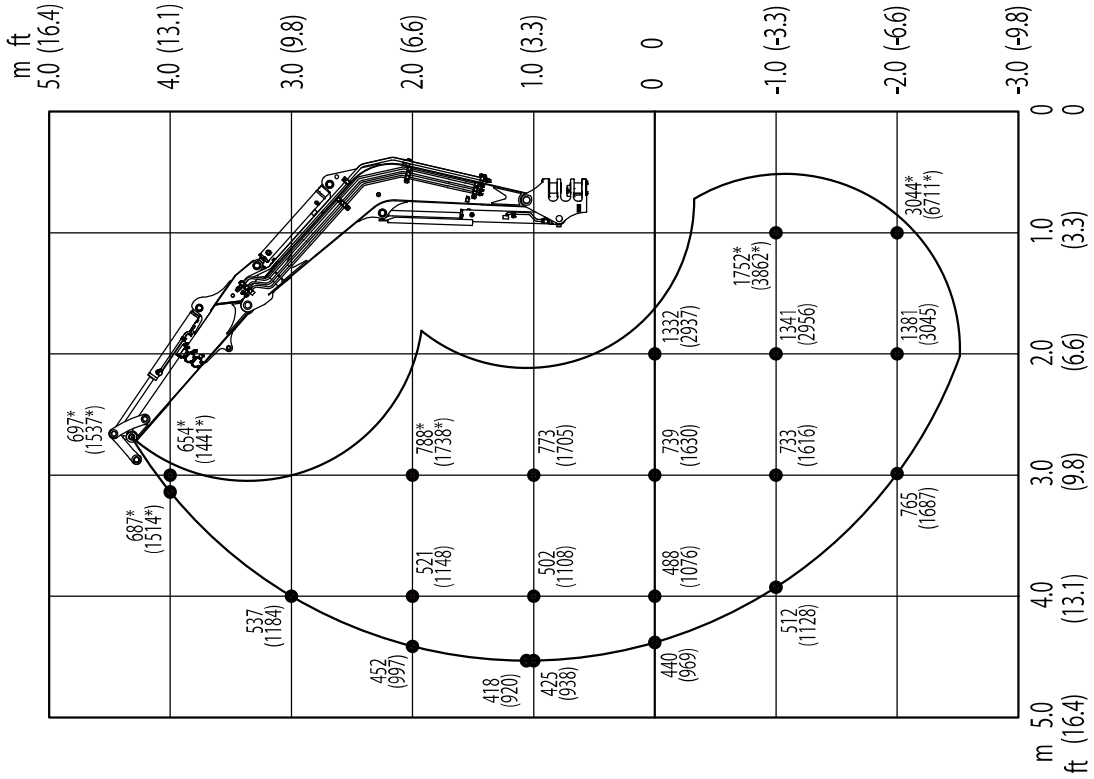

Over Rear

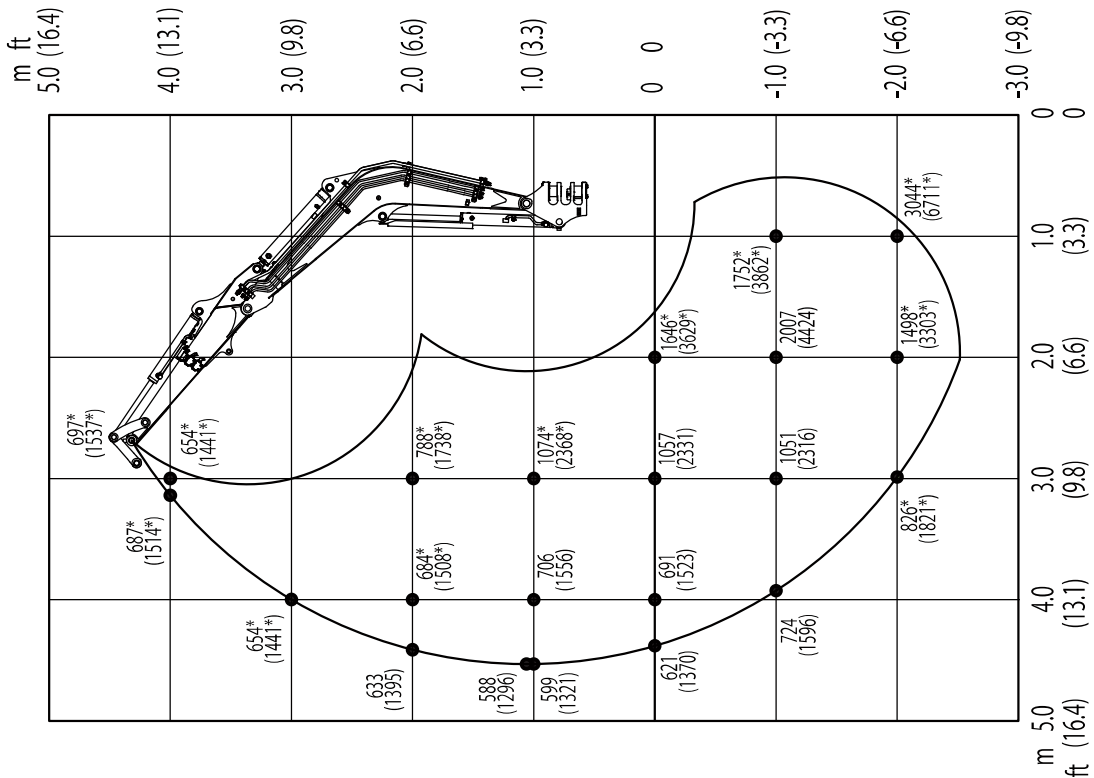

Units: kg(lbs.)



<Canopy> Long arm

Over Front ; Dozer Blade Up

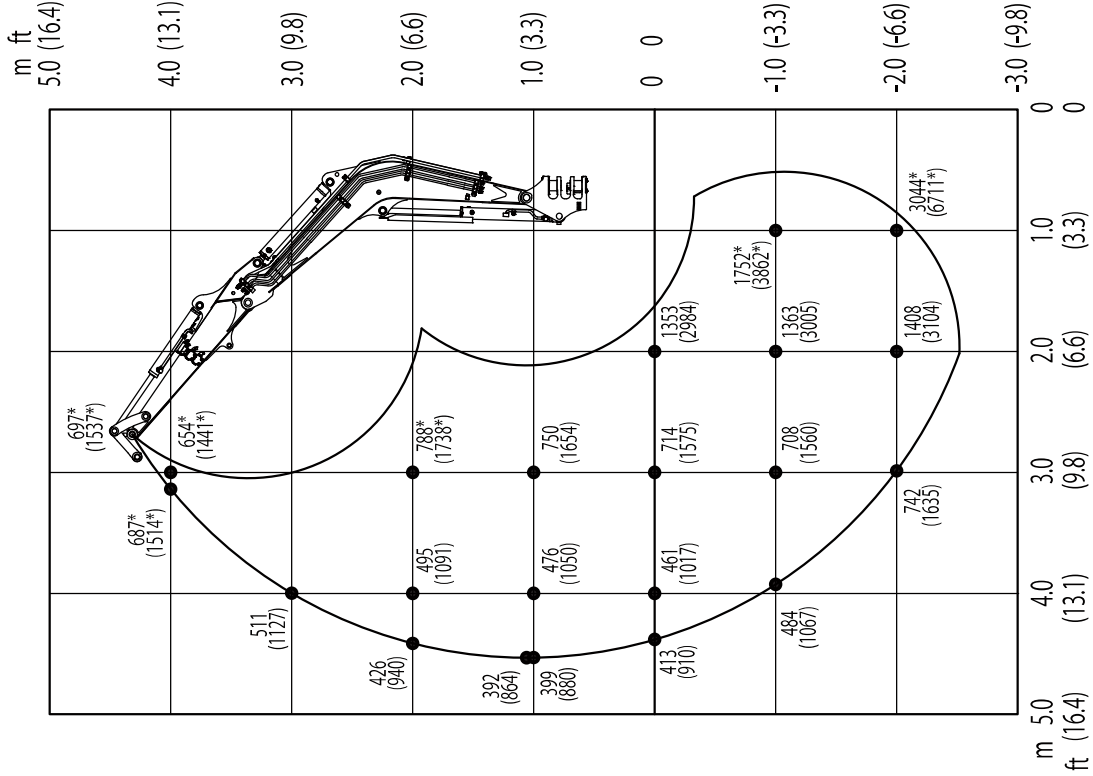

Over Front ; Dozer Blade Down  
(If equipped with an emergency shut-off valve)

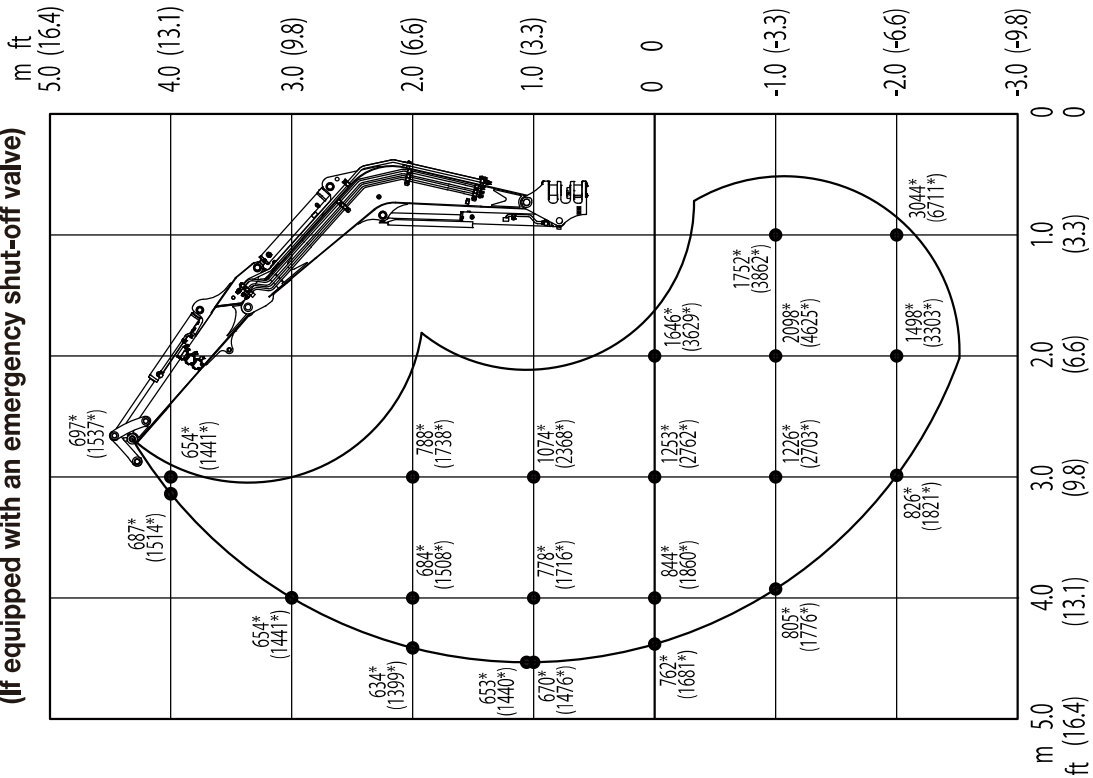

Units: kg(lbs.)



SPECIFICATIONS  
LIFTING CAPACITIES

<Canopy> Long arm

Over Side

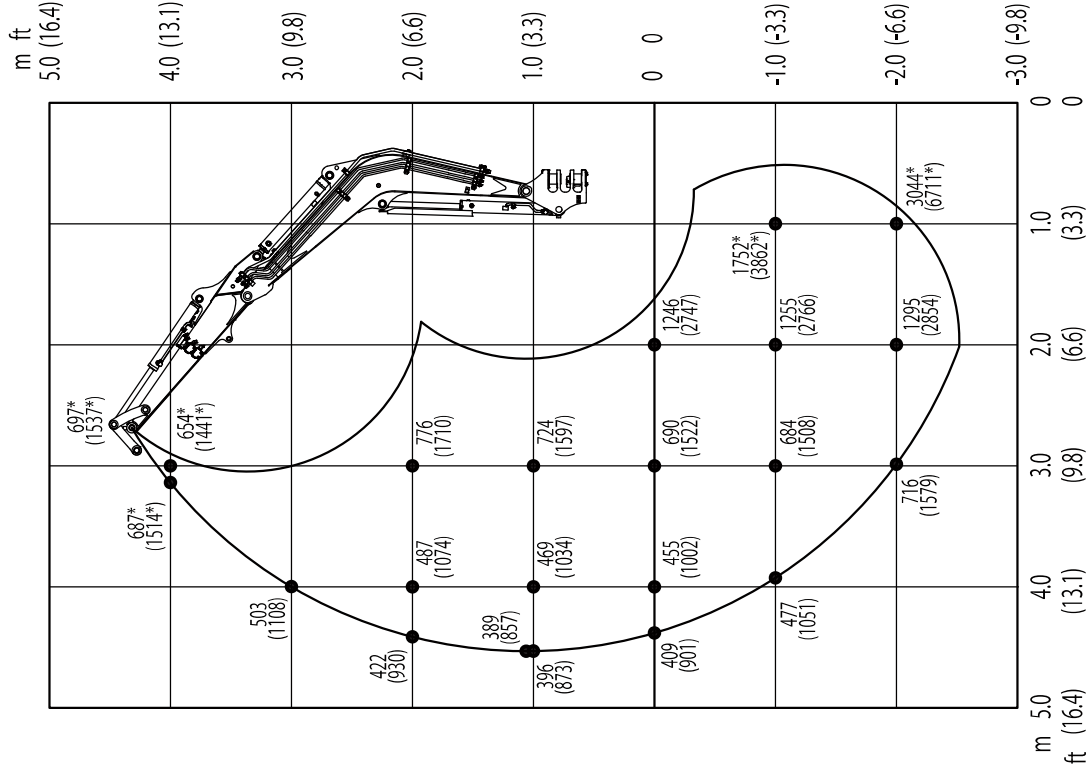

Over Rear

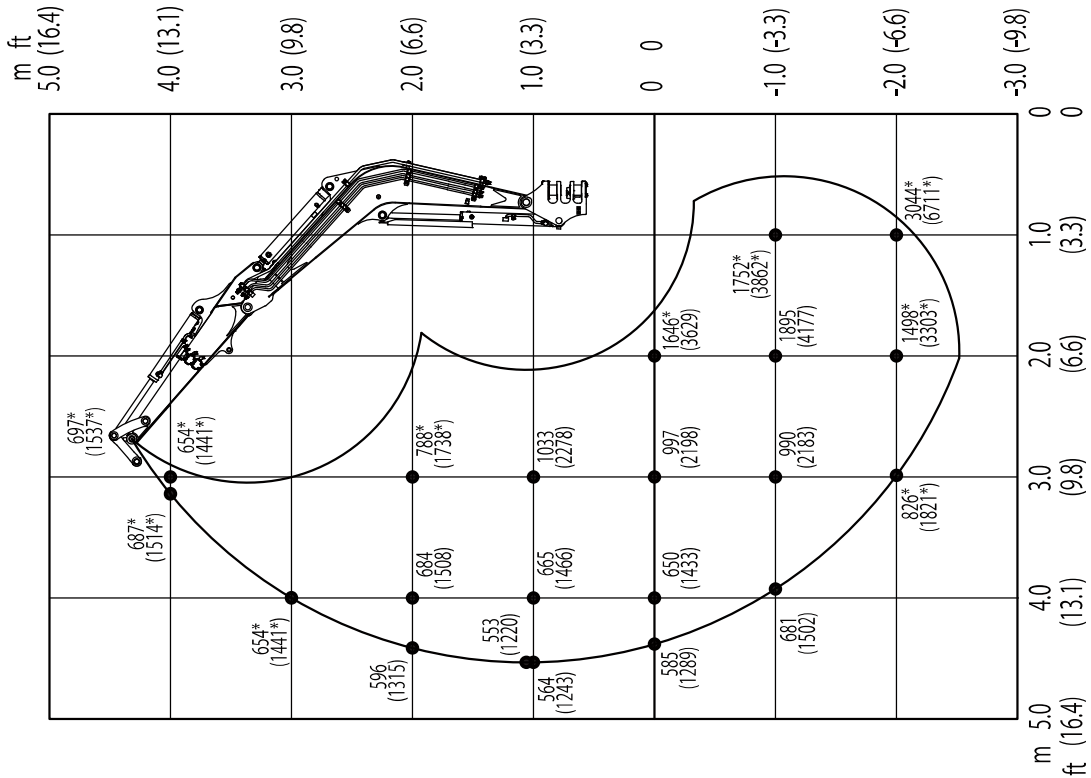

Units: kg(lbs.)